



Trituradora forestal adaptable a todo tipo de tractores entre 80 - 150 CV.
 Apta para el triturado de montes y parcelas, claros, cordones de poda, limpieza de líneas, apertura de pasos, monte en pie, etc., generando aportación de materia orgánica al suelo.
 De concepción forestal, con giro de martillos 360°, con diseño de martillo trapezoidal, posee grupo retrasado, para la disminución de la angulación de los nudos en la transmisión.
 Equipada con tercer punto hidráulico incorpora rotor POLSER + de 550 mm de diámetro.
 Enganches: fijo y desplazable.

CARACTERÍSTICAS

- ▶ Chasis en chapa antidesgaste de 10 mm.
- ▶ Rotor POLSER + de Ø 550 mm.
- ▶ Grupo SERRAT para 150 CV.
- ▶ Transmisión lateral por correas 3/4 XPC.
- ▶ Martillos forestales forjados SERRAT escamoteables 360° o diente fijo con punta de tungsteno o cuchillas DRR.
- ▶ Soportes de rodamiento de rotor en acero.
- ▶ Rodamientos oscilantes de doble hilera de rodillos.
- ▶ Cortina delantera de protección.
- ▶ Toma de fuerza de 540 rpm (1.000 rpm a partir de T-1800).
- ▶ Sistema antialambres en rotor.
- ▶ Contramartillos en acero.
- ▶ Patines.
- ▶ Tercer punto hidráulico.
- ▶ Modelo construido según la Normativa CE.
- ▶ Indicaciones de seguridad visibles al personal.







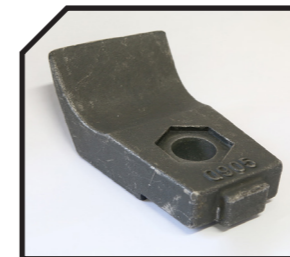



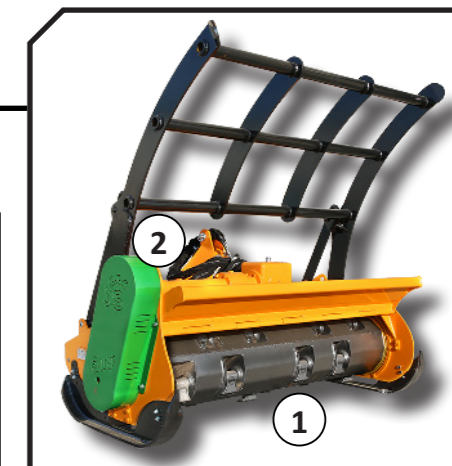
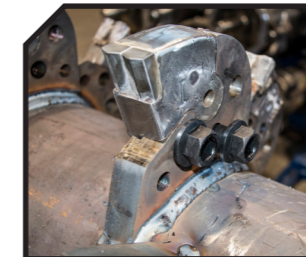

1. Martillos escamoteables
2. Tercer punto hidráulico

Cuchillas DRR



Sistema FIXE TOP



MODELO	 mm	 KW-CV				 KG	N.º CORREA TIPO	 A mm-in	 B mm-in	 C mm-in	
T-1400	1400	60 - 80 112 - 150	12	36	19	1040	3 XPC	1680-66"	1340-53"	1010-40"	540
T-1600	1600	67 - 90 112 - 150	12	40	22	1160	3 XPC	1880-74"	1340-53"	1010-40"	540
T-1800	1800	74 - 100 112 - 150	16	45	24	1253	4 XPC	2080-82"	1340-53"	1010-40"	1000
T-2000	2000	82 - 110 112 - 150	16	50	26	1325	4 XPC	2280-90"	1340-53"	1010-40"	1000
T-2300	2300	96 - 130 112 - 150	20	58	29	1510	4 XPC	2580-102"	1340-53"	1010-40"	1000

OPCIONES

- ▶ Rotor reforzado
- ▶ Tapa de correas compactas
- ▶ Preparación tripuntal delantero (grupo)

- ▶ Rueda libre

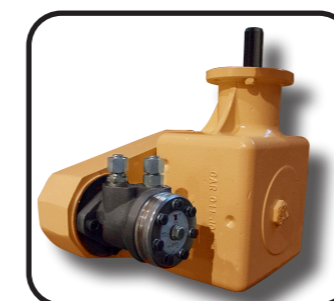

▶ Hidrahelp

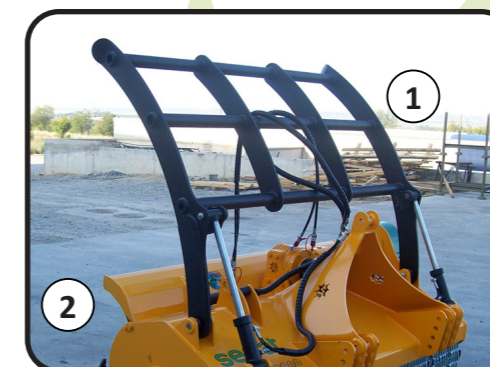

1. ▶ Abatidor
2. ▶ Portón trasero hidráulico

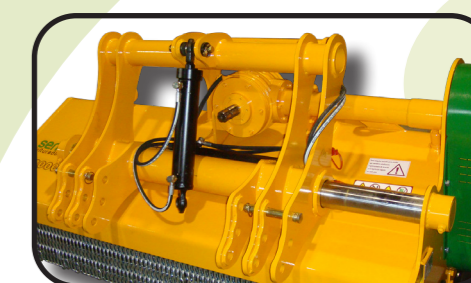

▶ Desplazable hidráulico

